

 **MISUTONIDA**
italian style **4x4**
accessories

FIAT SEDICI

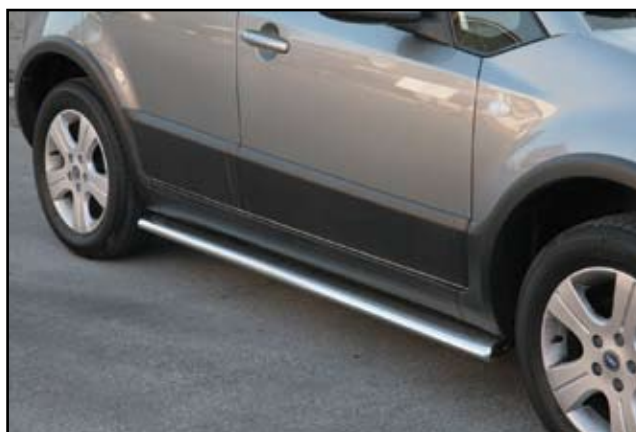

Item Code

Codice Articolo

Référence Article

: TPSO/193/IX

GB

STAINLESS STEEL
OVAL SIDE PROTECTIONS







ITA

TUBI PROTEZIONE SOTTOPORTA
OVALE IN ACCIAIO INOX

FR

PROTECTIONS LATERALES
OVALE EN ACCIER INOX

FIAT SEDICI

Part List		
Lista della bulloneria		
Liste des pièces		
A		M10 x 4
B		Ø 10 x 4
C		Ø 10 x 4
D		TPS180C x 4
E		TPS180D x 2
F		TPS180E x 2

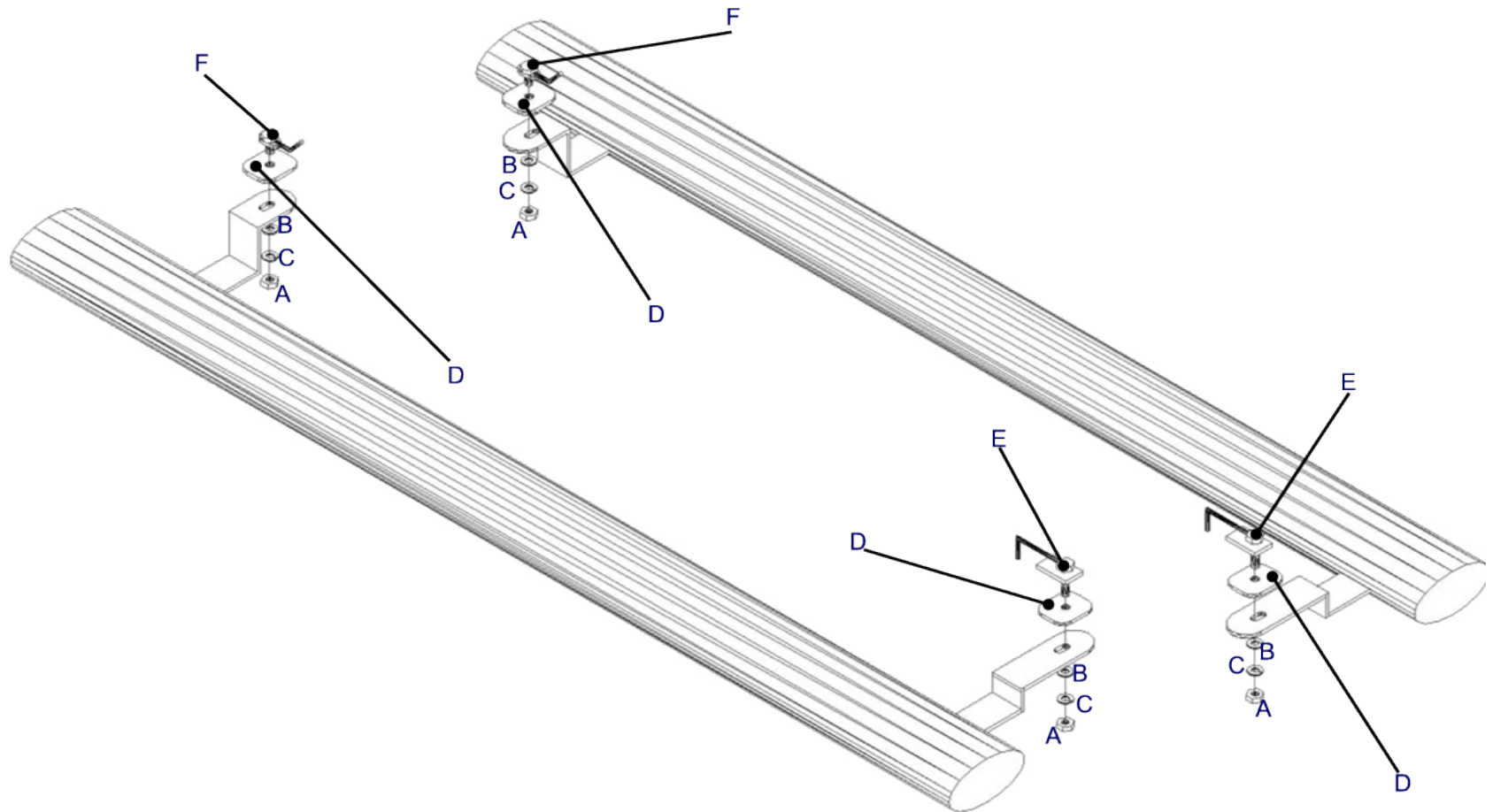

 **MISUTONIDA**
  *italian style* **4x4**
accessories



1



2



3



4



5

Date Data Date	Item Code Cod.Articolo Réf. Article	Vehicle model Modello Veicolo Modèle de Voiture
30/01/07	TPSO/193/IX	FIAT SEDICI

Checked and approved by
Controllato ed approvato da
Controlé et approuvé par

**Botta
 Pietro**

MISUTONIDA
 italian style accessories **4x4**

GB**FITTING
INSTRUCTIONS**

1. Remove the plastic caps located in the front side (picture 1).
2. Insert E and F as shown in pictures 2 and 3 making them come out as shown in pictures 4 and 5.
3. Fit the TPS using A,B,C and D.
4. Tighten all the set of bolts.

ITA**ISTRUZIONI DI
MONTAGGIO**

1. Rimuovere i tappi in plastica situati nella parte anteriore (foto 1).
2. Inserire E e F come indicato nelle foto 2 e 3 , facendoli fuoriuscire come indicato in foto 4 e 5.
3. Montare i TPS utilizzando A, B, C e D.
4. Serrare tutta la bulloneria.

FR**INSTRUCTIONS DE
MONTAGE**

1. Enlever les bouchons en plastique qui se trouvent dans la partie antérieure (photo 1).
2. Insérer E et F comme indiqué dans les photos 2 et 3 et les faire sortir comme indiqué dans les photos 4 et 5.
3. Monter le TPS en utilisant A, B,C et D.
4. Serrer toute la boulonnerie.

Date Data Date	Item Code Cod.Articolo Réf. Article	Vehicle model Modello Veicolo Modèle de Voiture
30/01/07	TPSO/193/IX	FIAT SEDICI

Checked and approved by
Controllato ed approvato da
Controlé et approuvé par

**Botta
Pietro**

 **MISUTONIDA**
 *italian style* **4x4**
accessories